

THE GRAVES AT TELL ER-REQEISH

WILLIAM CULICAN

Abbreviations

- Ajjul* W. M. F. Petrie, *Ancient Gaza*, II, 1932.
- Amiran* Ruth Amiran, *The Ancient Pottery of Eretz Israel*, Jerusalem, 1963 (Hebrew). Bracketed figures after references to illustrations of Reqeish pots are to those in the English version, *Ancient Pottery of the Holy Land*, Rutgers University Press, 1970.
- Anthedon* W. M. F. Petrie, *Anthedon and Sinai* (London, 1937).
- Ashdod 1* M. Dothan, D. N. Freedman, 'Ashdod I', *Atiqot*, VII, 1967.
- Ashdod 2* M. Dothan, 'Ashdod II-III, the second and third seasons of excavations 1963, 1965', *Atiqot* IX-X, 1971.
- Chapman* S. V. Chapman, 'A catalogue of Iron Age Pottery from the Cemeteries of Khirbet Silm, Joya, Qrayé and Qasmieh of South Lebanon', *Berytus*, XXI, 1972, pp. 55-194.
- CPP* G. Garrow Duncan, *Corpus of Palestinian Pottery*, London, 1938.
- Fara* W. M. F. Petrie, *Beth Pelet I*, London, 1930.
- Gerar* W. M. F. Petrie, *Gerar*, London, 1928.
- Halif* A. Biran and R. Gophna, 'An Iron Age Burial Cave at Tel Halif', *Israel Exploration Journal*, 20, 1970, pp. 151-169 (also *Eretz Israel*, 9, 1969, pp. 27-39).
- Hazor* Y. Yadin et al. *Hazor II*, Jerusalem, 1960.
- Lachish* O. Tuffnell, *Lachish III: the Iron Age*, London, 1953.
- Samaria* K. M. Kenyon, 'Israelite Pottery, in J. W. Crowfoot et al. *Samarra-Sebaste III: the Objects from Samaria*, London, 1957, p. 90 ff.
- TBM I, III* W. F. Albright, 'The Excavation of Tell Beit Mirsim,' *Annual of the American Schools of Oriental Research*, XII, 1930-31; XXI-XXII, 1941-3.

Between 1928 and 1930, W. M. Flinders Petrie excavated part of the site of Tell Fara and several cemeteries on the north, south and west of it. In the north cemetery (Cemetery 200) described in *Beth Pelet I*, were discovered twenty-seven cremation burials¹ concentrated around its south-east area. In these the pottery vessels which had been used as burial urns had been

Note: All scales appearing in photographs are in centimeters. Drawings are reduced approximately 1 to 5.

1. Burials 215-219; 250-272.

placed below the ground between the rectangular stone-lined collective tombs of the cemetery. These latter were dated by Petrie to the XXth and XXIInd Dynasties and Miss O. Tuffnell, who wrote the short account of the cremation graves in *Beth Pelet I*, p. 13, observed that their placing suggested that the positions of the stone-lined tombs were known to the depositors of the cremation urns. With one exception, none of the cremation burials was found adjoining or on top of the built tombs: this was the cinerary urn found inserted into tomb 223, just under the roofing slab. The suggestion is that no great chronological gap separated the two burial types. However, it was observed that iron armlets were prevalent in the cremation urns along with the charred bones.² It appears that the charred human bones were placed in urns together with smaller pieces of pottery and in some cases covered with an inverted bowl. Very few details are given; but the importance of the cremation urn-field with its comparison to the then recently excavated urn burials in the precinct of Tanit at Carthage, did not escape the attention of the excavators. A few similar cremation burials were later found by Petrie at Tell el-Ajjul and wrongly attributed by him to the XVIIIth Dynasty.³ These too were associated with an inhumation graveyard. Today, with cremation urn fields known at Akhziv,⁴ 'Atlit⁵ and Khaldeh,⁶ in the area of metropolitan Phoenicia, this form of burial has become of great importance for the definition of Phoenician culture. Any information which either narrows or defines the gap between Philistine (Iron I) and Phoenician (Iron II) on the coast of Syria, Lebanon and Palestine is especially valuable at the present time, when Phoenicians are becoming studied more intensely than before. This short article is concerned to preserve information concerning a third Iron Age cremation site in south Palestine at Tell er-Reqeish (Tall al-Arqeish or Abu

-
2. Burials 251, 264 and 271 had bronze and iron armlets; burial 262, omitted from the register, had iron arrow-heads, *Beth Pelet I*, p. 13, pl. LXVIII.
 3. *Ancient Gaza II*, burials 1102, 1106, 1120, 1134, 1135-6, 1151, 1153 of the J cemetery, and 1160 of the A cemetery. There is no comment on them in the text.
 4. M. Prausnitz, 'Red-polished and Black-on-Red Wares at Akhziv, etc.', *Praktikōn tou protou diethnous Kyprologikou Synedriou*, Nicosia 1972, pp. 151-6; 'Israelite and Sidonian burial rites at Akhziv', *Proceedings, Fifth World Congress of Jewish Studies*, 1970, pp. 85-89.
 5. C. N. Johns, 'Excavations at the Pilgrims' Castle 'Atlit', *QDAP*, VI (1936), pp. 121-152. The author was aware of the comparisons which could be made between the 'Atlit cremations and those at Ajjul and Fara. He did however overstress the uniqueness of the cremation burial pottery with regard to that of the inhumation burials at Fara.
 6. R. Saidah, 'Fouilles de Khaldeh', *Bull. Mus. Beyrouth*, XIX (1968), pp. 51-90.

Ruqeish, south of Gaza and south west of Deir el-Balah) now in the 'Gaza Strip'.

The site (like Khaldeh) consisted of a low mound on the seashore partly covered with sand. Some thirty cremation burials were found whilst digging foundations for a police post and excavated by the Palestine Department of Antiquities in 1940 by Mr. J. C. Ory.⁷ Some of the excavated material has long been known to visitors to the Palestine Museum, but the unfortunate political events of the time prevented publication. Apparently not all the excavated material reached the Museum and that which did is now slightly confused. The skulls, bones and contents of the cremation urns cannot now be located. The remains in the cremation urns are described as being calcined, of human adults and rather well-grown children.

Fortunately some drawings were made after excavation of the larger tomb groups; and it is largely for the presentation of these from the Palestine Archaeological Museums archives that this paper is written, *faute de mieux*.⁸ The significance of the site was briefly noted by Dr. D. B. Harden,⁹ and some of the pottery illustrated in *Amiran*. Students of Palestinian ceramics have been struck by quality of the pottery from it.¹⁰ The burials were made in isolated loci in the sand and were apparently all cremations except for a burial containing four unaccompanied skulls, and a few pieces of isolated pottery.

GRAVE I. Fig. 1

Fig. 1 R I (453)

Storage jar with bulging body, rounded shoulder and upward-narrowing neck. The base narrows to a rounded point. Both shoulder, neck and base are off-set and probably separately made. The handles are featured with a deep channel along their length. Fine compact pink-buff clay with a thick creamy-pink slip. Incised X on upper body made before firing. Polished.

Fig. 10a R 1a (454)

Bowl with angular profile and well-made disc foot, slightly concave underneath. The clay is buff, well purified. The inside and upper-half of the outside are covered with a crimson-red horizontally burnished slip.

R 1b
(unnumbered)

Body fragments of a juglet of Black-on-Red ware.

-
7. *QDAP*, 10, 1944, p. 205 and C. N. Johns, 'Discoveries in Palestine since 1939', *PEQ*, 1948, p. 88, and pl. II, fig. 1 (here urns 474, 496, 478, 494).
8. I am grateful to Mr. Lankester Harding who put these drawings at my disposal during a visit in 1966.
9. *The Phoenicians*, 1962, p. 60.
10. Palestine Archaeological Museum, *Iron Age Gallery Book*, p. 9, Nos. 598-627.

Figure 1

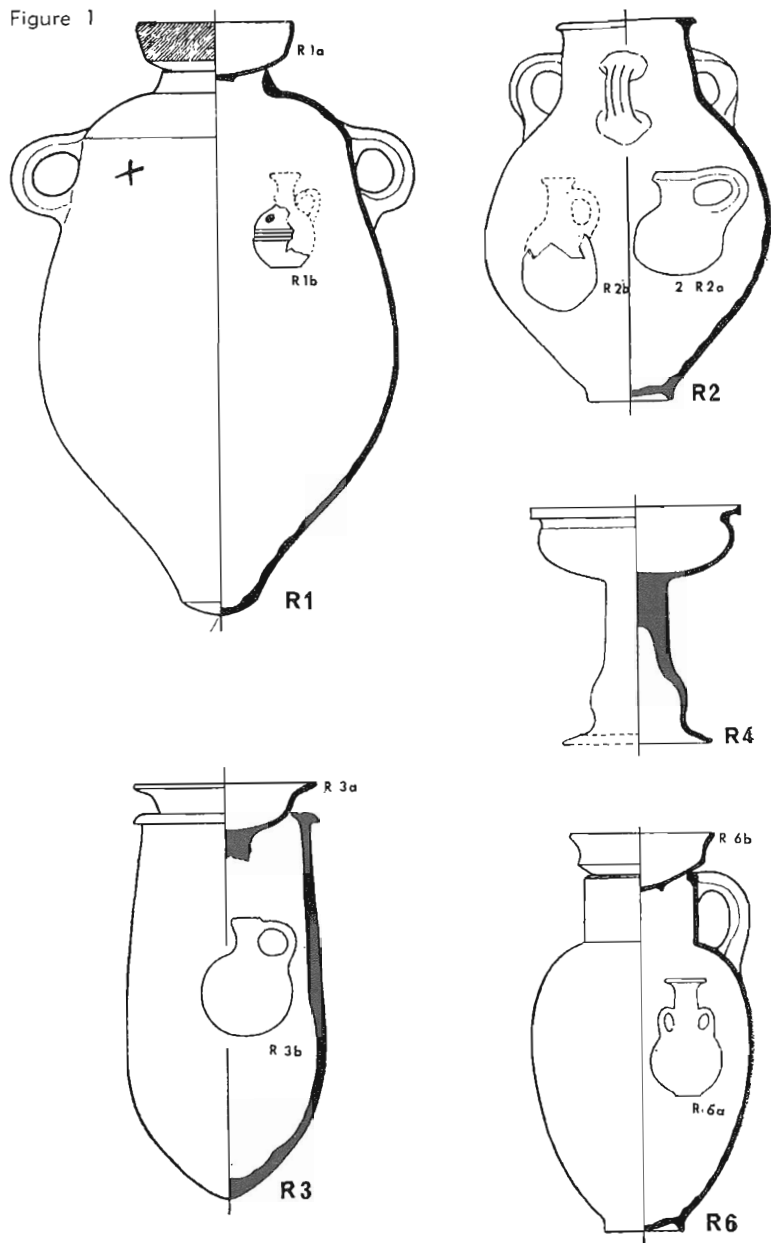

GRAVE 2. Fig. I

Fig. 6 R 2 (455)

Three-handled jar, with inward sloping, slightly bulging neck, ring base. Handles have deep ridges down the back. The rim is flattened. Buff fabric with fawn slip. Contained burnt bones, scarabs (456-7) and beads (458), *Amiran*, p. 290, fig. 455 (p. 238 photo 242).

R 2a (459)

Squat juglet, globular with out-swung handle. Orange-buff clay covered with a whitish slip.

R 2 (460)

Base of a juglet.

Fig. 13 R 2c (461)

Body of a Black-on-Red juglet, dull orange-buff ware. Remains of black painted concentric circles on neck opposite handles.

GRAVE 3 Fig. I

Fig. 10b R 3 (462)

Storage jar, handleless dolium with outward-turned rim. Thick light grey clay, baked to a lighter hue on exterior. Wet-smoothed.

R 3a (463)

Upper part of a chalice, buff ware with grey coat.

R 3b (464)

Globular hand-made short-necked juglet. Orange-buff clay with thick bright-red slip.

R 3c (465)

Base of a bowl (not located).

GRAVE 4 Fig. I

R 4 (466)

Tall 'chalice' of greyish pink clay with multiple white grits. No slip, though there is a powdery white coating which appears to be a wash. The rim is finely turned to form a flange.

Together with this were found fragments of a bowl (unnumbered).

GRAVE 5

R 5 (467)

One-handled pitcher with well-turned ring base. Buff ware, baked to grey-buff with thick greyish slip.

Fig. 13 R 5a (468)

Two-handled flask; globular body, distinct ring-base, plain rim. The clay is dark reddish buff. Heavy red slip on outside with horizontal burnishing on neck and body; oblique burnishing on shoulders. Rim worn.

Fig. 13 R 5b (469)

Small handmade juglet of black clay with lighter black slip, polished.

Fig. 11 R 5c (470)
bis

Hemispherical bowl of grey-buff clay with grey particles, baked to orange-buff on the exterior. The inside is entirely covered with red slip except for a circle in reserve. The slip is wheel-burnished on the walls, but the inner base has hand-burnish in parallel strokes.

GRAVE 6 Fig. I

Fig. 8 R 6 (471)

One-handled pitcher of orange-pink clay, well-purified and covered outside and in with a self-coloured polished slip. Ring base.

Fig. 12 R 6a (472)

Two-handled flask. Globular body narrowing to a small ring-base. Deep brownish-orange clay with grey cindery grits and scattered large white grits. Remains of a heavy red wash.

Fig. 10a R 6b (473)

Carinated bowl with ring base. Deep pink well-purified clay, covered all over with a deeper pink polished slip.

- GRAVE 7 Fig. 2
Fig. 7 R 7 (474) Jar-shaped urn with handles from shoulder to rim. Orange-buff clay covered with a bright red slip on the outside. Vertical spaced burnished strokes on the body; the surface between them is very matt. Three lines of matt black paint on body, worn; with remains above of two red painted lines. *Amiran*, p. 268, fig. 474 (photo 234).
R 7a (475) Handmade juglet of black ware.
- GRAVE 8 Fig. 2
Fig. 6 R 8 (476) Three-handled jar with wide neck and narrow concave base. The rim is flat and triangular in section, sloping inward. There is a thick median handle-ridge on the neck. Fabric deep reddish-brown clay with multiple buff black, white and brown grits. Heavy red flaky slip on outside and inside neck, vertically burnished with bold strokes on both body and outer neck. *Amiran*, pp. 290-1, fig. 249 and 6 (p. 238 photo 241).
R 8a (477) Globular sagging handmade juglet of black ware, black polished slip.
- GRAVE 9 Fig. 2
Fig. 7 R 9 (478) Jar with two horizontal, deeply ridged handles conical neck with median groove and oblique offset shoulder. Pale orange-buff clay with self-coloured slip, pinkish horizontally hand-burnish on body with uneven intersecting strokes. Vertical burnish on neck. The rim is broken off, but apparently flared outwards. *Amiran*, p. 268, fig. 240, p. 269.5 (p. 72, 6 and photo 232).
Fig. 13 R 9a (479) Small black hand-made juglet, grey-black clay with black polished slip, vertically burnished.
R 9b (480) Base of a bowl of plain ware.
- GRAVE 10 Fig. 2
Fig. 8 R 10 (481) One-handled pitcher with inward-sloping neck, rim turned inwards and flattened on top. Heavy wheel ridges inside neck. A ring base is turned out of the continuous curve of the wall. Deep pink clay with black grits. Thick smooth fawn slip inside and out.
R 10a (482) Pedestal foot of a dish-on-stand, or 'chalice'.
R 10b(483) Parts of two hand-made juglets of black ware.
- GRAVE 11 Fig. 2
R 11 (484) Urn of crater shape with rim turned slightly outwards and low ridge in middle neck. Grooves at handle level made before handles were attached. Vivid orange-pink friable clay with thick, whitish grey wash. Ring base.
R 11a (485) Deep bowl with flat base and walls flaring outwards. Rim slightly out-turned. Ring base below. Bright orange-buff clay with thick whitish-buff slip.
Fig. 13 R 11b(486) Body of a globular juglet on Black-on-Red ware, corroded. The fabric is greying orange-buff.
R 11c (487) Body of a two-handled flask of fine buff ware, undecorated.

AUSTRALIAN JOURNAL OF BIBLICAL ARCHAEOLOGY

- GRAVE 12 Fig. 2
Fig. 7b R 12 (488) Storage jar of dolium shape with thickened outward-sloping rim. Pinkish-buff clay with polished pink-fawn slip.
- Fig. 11 R 12a (489)
bis Deep bowl with high ring base. Three horizontal mouldings on the upper part of the body; heavy wheel marks on the inside. Deep orange-buff clay with grey core. Chesnut brown slip covering entire inside and upper part of outside, burnished.
- GRAVE 13 Fig. 3
R 13 (490) Jar-shaped urn of orange-buff clay with thick pale fawn slip covering the outside and well inside the neck. Heavy base with a central bump which prevents it standing upright. Rim with moulded collar. The neck is off set from the body. Multiple grooves on shoulder.
- Fig. 12 R 13a (491) Tall Black-on-Red handle-ridge juglet. Refined orange clay with highly polished red slip with encircling lines of matt black paint. Flat base.
- R 13b (492) Bottom part of a dipper juglet—not located.
- Fig. 11 R 13c (493) Bowl of pale brown clay, hemispherical but paunching, with upper body turning slightly inwards. Distinct foot, concave base. Deep dusky pink slip on the interior and outer rim. Burnished inside and out with heavy, widely spaced striations. A deep score mark stops the slip on the outer rim.
- GRAVE 14 Fig. 3
Fig. 7 R 14 (494) Urn similar to 490, but with narrower neck and higher ring base. Three regular grooves on the upper body at handle level and near the base.
- GRAVE 15.
Fig. 7 R 15 (495) Urn of crater shape with neck slightly bulging and narrowing towards the top, rim rounded and slightly off set. There is a deep groove on the upper part of the body at handle level. The under-base is convex: the urn does not stand well. Pinkish-orange clay with small black and white grits. The outside is smoothed and covered with a thick rust-coloured slip, which extends well inside the neck.
- GRAVE 16 Fig. 3
Fig. 7 R 16 (496) Urn of crater shape, squat, with incurving neck with medial ridge and flattened rim. Grey-brown clay with heavy fawn slip inside and out. Heavy burnishing on outside, horizontal on body, vertical on neck. Nipple on each side between handles.
- Fig. 12 R 16a (497) Handle-ridge juglet of refined orange clay, body sub-globular to piriform. The clay is light orange-buff with a polished slip of the same colour. The mouth is painted above and underneath with red paint and there is a single red line beneath the red zone. The neck is painted with black lines and two red zones.
- Fig. 13 R 16b (498) Black-on-Red handle-ridge juglet about 4½ in. Refined orange fabric, orange-red polished slip. Flat base. Matt black encircling lines.

Figure 2

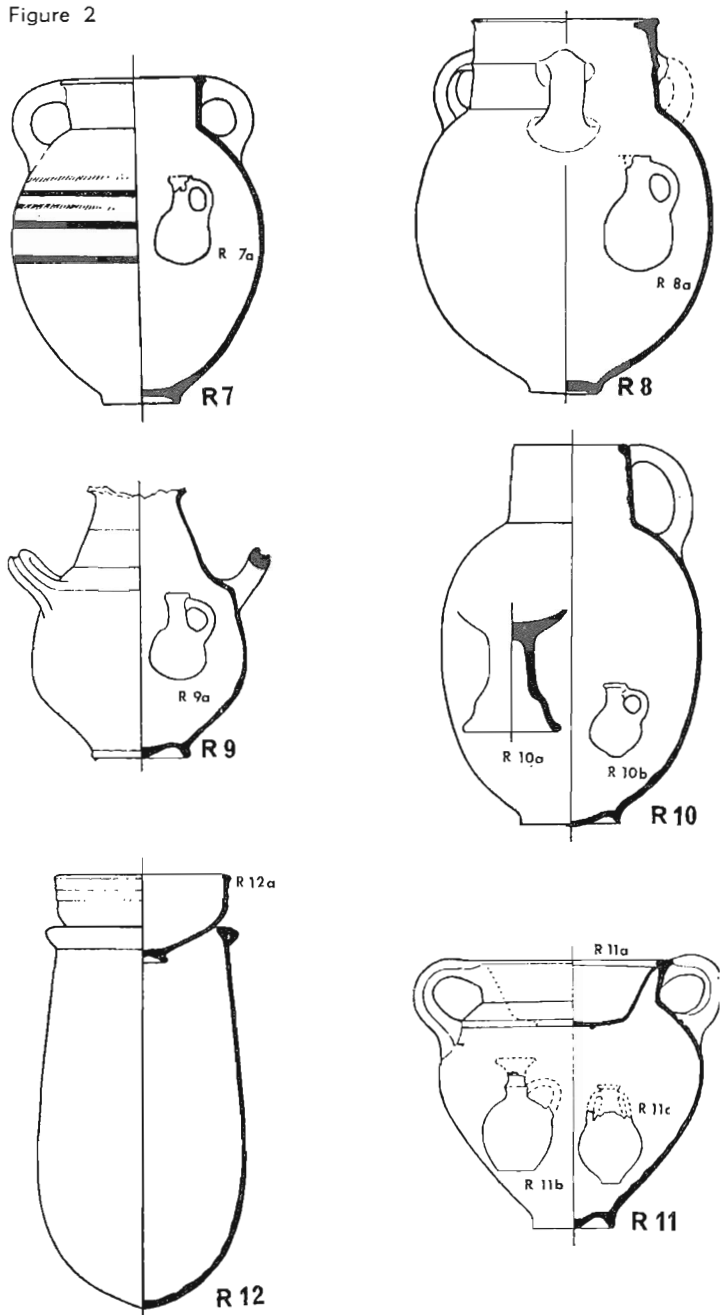

- GRAVE 17 Fig. 3
Fig. 6 R 17 (499) Urn with two handles, globular rising body. The handles join to a handle-ridge on the neck. The collared rim slopes inwards and is featured with three ridges. Slightly spreading ring base.
- GRAVE 18 Fig. 3
Fig. 6 R 18 (500) Urn with two handles from shoulder to thickened rim, globular sagging body. The ring foot is slightly turned outwards, the under base is convex. Heavy grooves between handles and base of neck. Two nipples of clay are placed on each side at this level. The fabric is buff with pinkish-buff slip vertically burnished. In the middle of the body these horizontal burnished marks overlie a zone of vertical ones.
- GRAVE 19 Fig. 4
R 19 (501) Three-handled urn with narrowing neck and flattened in-turned rim. The handles are rough and have slight twists in them. Heavy grooves at upper handle level, made before the handles were attached. Narrow, flat base with ring foot. *Amiran*, p. 291, fig. 6 (pl. 80, 5).
Scarabs (one missing).
- Fig. 14 (502-4)
GRAVE 20
Fig. 7 R 20 (505) Urn of crater shape with heavy ring base. Refined orange-buff clay. Outside surface wet-surface wet-smoothed. Heavy burnished strokes, oblique on body, vertical on neck, horizontal on shoulder—none on handles. Contained cremated bones and fragments of egg-shell. *Amiran*, p. 268, fig. 24. (photo 234).
(unnumbered) Fragmentary Black-on-Red juglet, brownish grey clay.
- GRAVE 21 Fig. 4
Fig. 10c R 21 (506) Storage jar of ovoid shape, oblique off set shoulder and thick standing collar-like rim. Rough pinkish-buff clay with traces of a thick, white coat.
- Fig. 13 R 2(a-c)
(507-9)
Fig. 12 R 21d (510) Globular hand-made juglets of black ware with black polished surface.
Juglet with rounded, slightly pointed base, and out-turned rim. Dull buff clay with traces of a red slip round the base.
- GRAVE 22 Fig. 4
R 22 (511) Storage jar of 'torpedo' shape, oblique off-set shoulder, slightly rounded, straight collar and thick well-turned rim. Greyish pink-buff clay with sandy grits. There is a pale whitish buff wash inside and out.
- GRAVE 23 Fig. 4
Fig. 7 R 23 (512) Urn of crater shape with slightly inset ring base. Low neck turned slightly outwards. The clay is deep red-brown with a thick buff-cream slip. Two pale orange zones painted round body. The rim and top of handles are painted with pale red and white squares, the white making what appears to be a lotus design on the upper handle attachments. *Amiran*, p. 268, fig. 243 (photo 232).

Figure 3

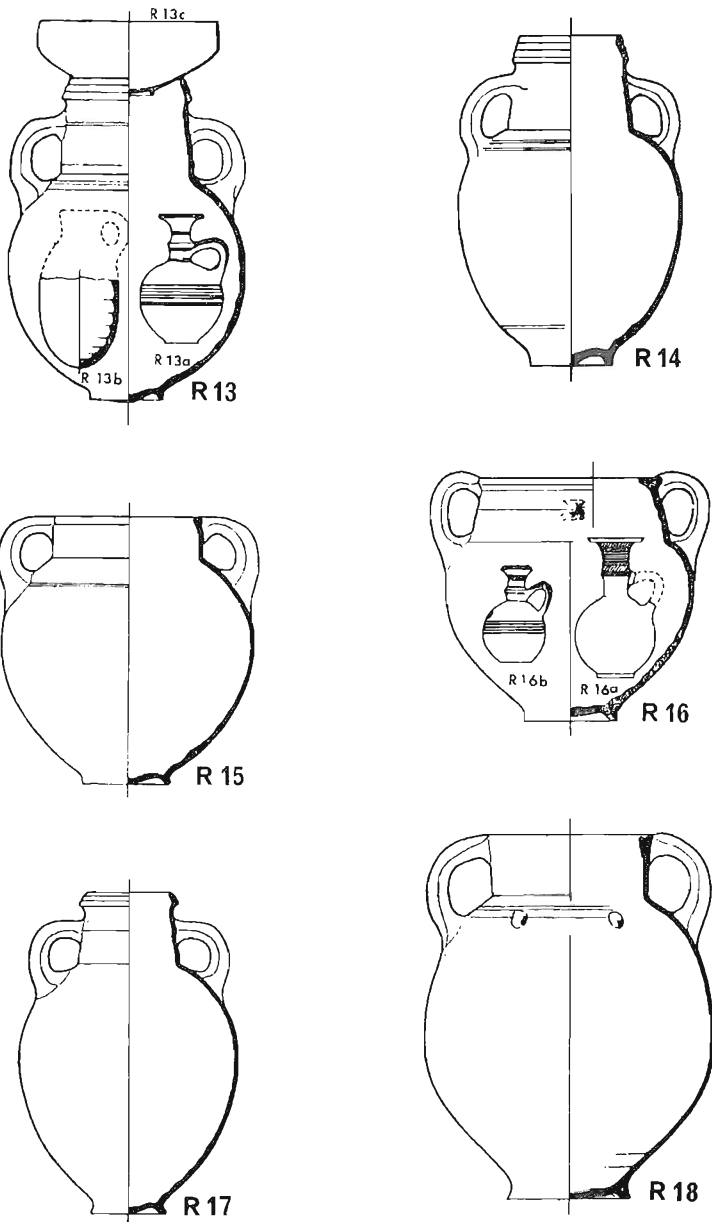

AUSTRALIAN JOURNAL OF BIBLICAL ARCHAEOLOGY

Fig. 13 R 22a (513) Disc-top juglet with ovoid body, flat down-turned rim. Pronounced handle-ridge and groove on neck. Red-brown clay evenly fired. Traces of bright scarlet slip.

GRAVE 24

Fig. 10a R 24 (514) Bowl with flat base and conical shape, straight sides. Light buff clay completely covered with mechanical slip.

GRAVE 25

Fig. 11 R 25 (515) bis Bowl, hemispherical with ring base and rim turned with oblique moulding. Zone of red paint on outside upper half and covering the inside with irregularly-spaced wheel burnish strokes. There is heavy wheel scoring just below the outer rim. *Amiran*, p. 242, fig. 219 (photo 211).

GRAVE 26

Fig. 11 R 26 (516) bis Bowl, hemispherical but irregular, with ring base and angular profile. Thin walls taper gently towards the rim. Pale orange-buff clay with thick chocolate coloured slip on the upper part of the outside and entire inside. Irregular burnish marks over slip.

GRAVE 27

Fig. 11 R 27 (517) bis Bowl like 516, the slip dark red, with wheel burnish strokes close-set.

GRAVE 28

Fig. 10a R 28 (518) Bowl, carinated with ring base. Deep brown, friable clay baking to orange-brown on the surface, with wet-smoothing in same shade. Circular ring burnish on inside and upper part of outside. The slip survives only where the burnish is strong.

GRAVE 29 Fig. 5a
R 29 (519)

Dipper juglet.

GRAVE 30
R 30 (520)

Black juglet.

GRAVE 31
R 31 (521)

Fragment of hand-made black juglet.

GRAVE 32
R 32 (522)

Stone burnisher.

POTTERY WITHOUT ASSOCIATED BURIALS

Fig. 7 (522)

Urn of crater shape similar to 495, but squatter and more globular and with wider mouth. The shoulder slopes more distinctly. Heavily ridged with wheel marks on the inside. The handles are ridged on the back. The slip is thinner and partly rubbed off by wheel burnishing.

Fig. 5b (525)

Storage jar of ovoid shape like R1. Sloped flat shoulder, straight rim. Brickly orange clay with large white grits; baked fawn on the outside and smoothed. It was dried lying on its side and has sagged. There is a large patch of orange coloration on this side made in firing, together with the impressions of a reed mat.

Figure 4

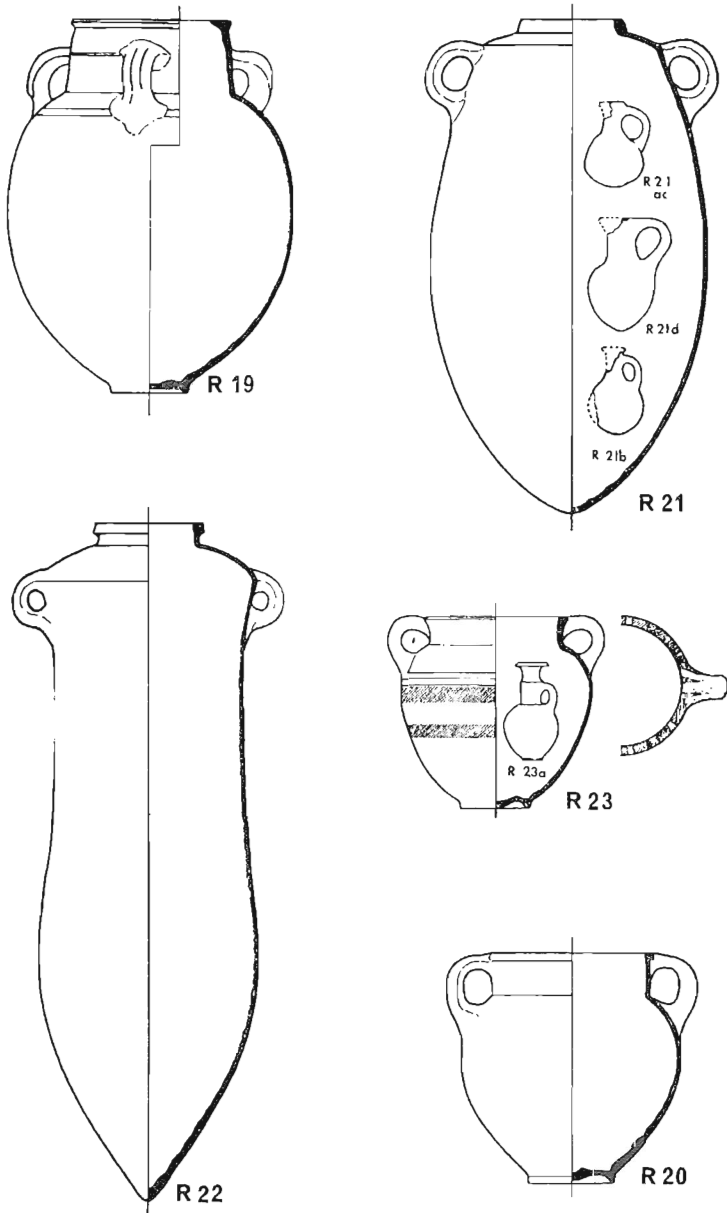
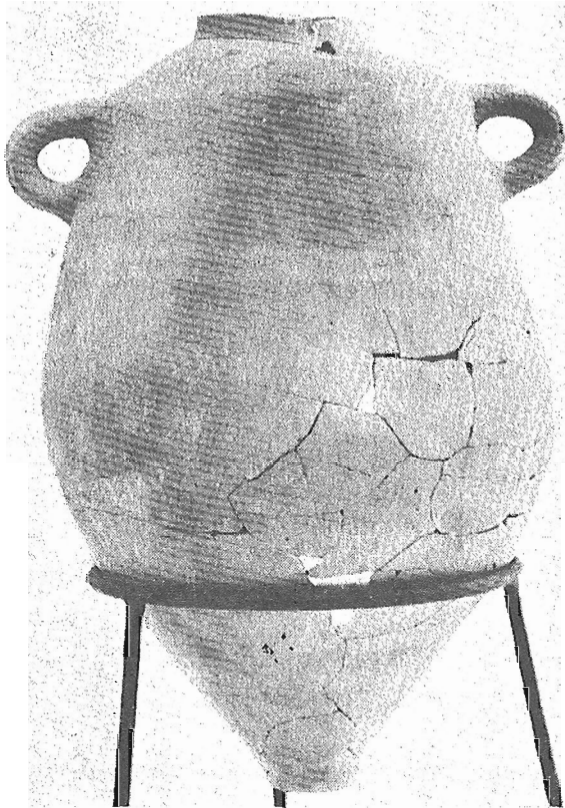
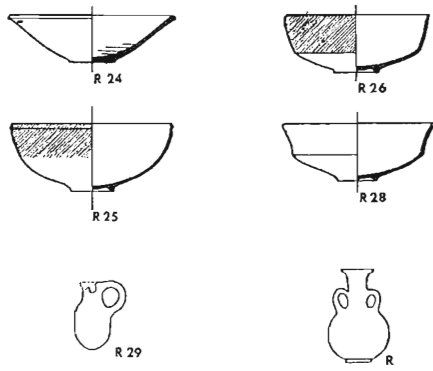

Figure 5



a

Figure 6

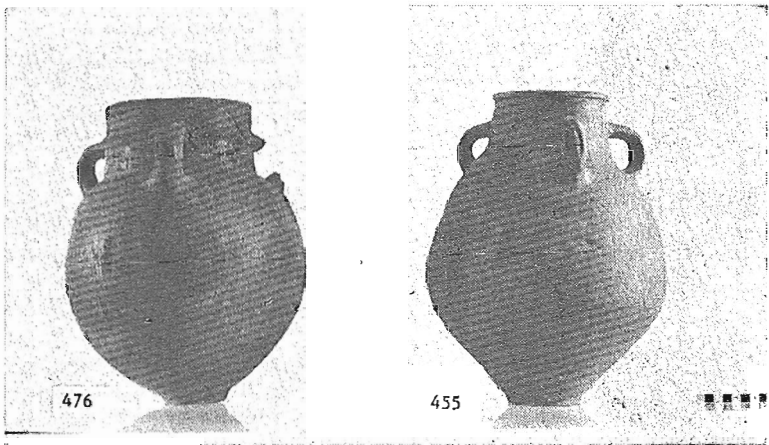

Fig. 9
(523, 526)
(527-530)

Fig. 5

Four fragments of plain pottery.
Four human skulls with dipper juglet.
Two hand-made urns, each with three handles. The shoulders are indented and the rims thickened. The upper bodies are slightly convex above the maximum diameter. Buff clay with much tempering and soft grits. Smoothed surface baked slightly pink. Irregular grooves on neck and shoulder.
Two-handled globular flask, light brown clay, red slip.

Even without its somewhat unusual characteristics, Reqeish pottery poses the usual knotty problems of the internal typo-

Figure 7

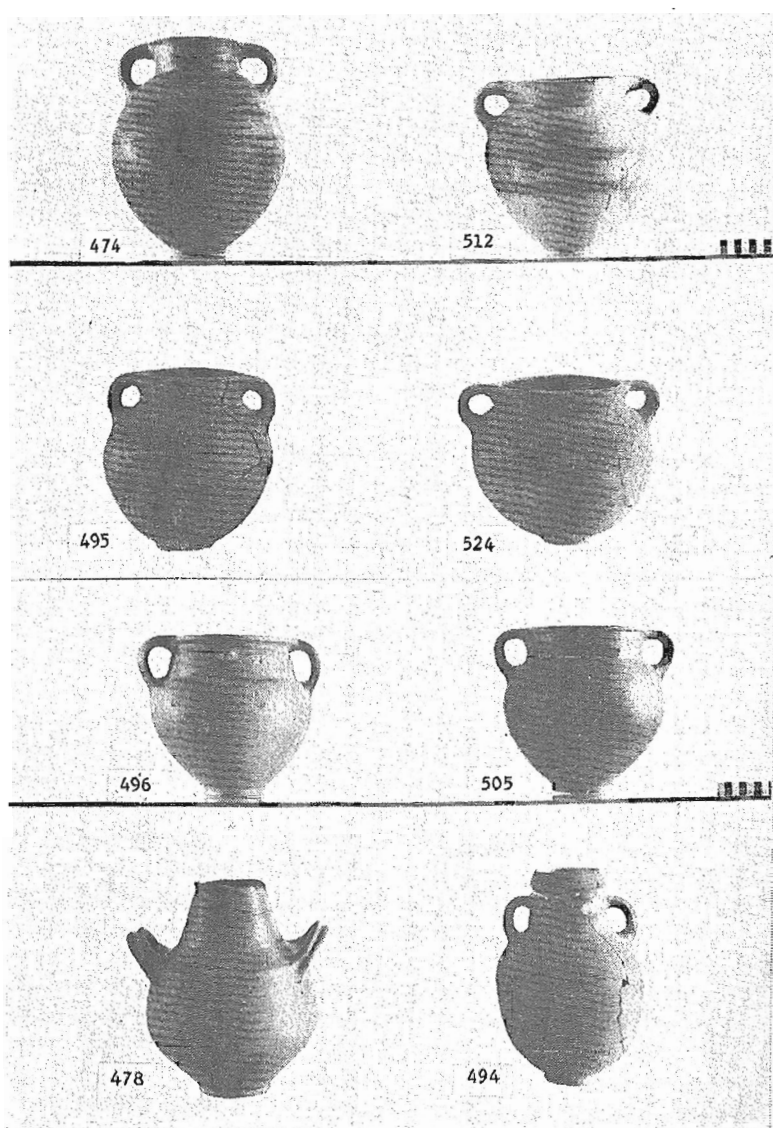
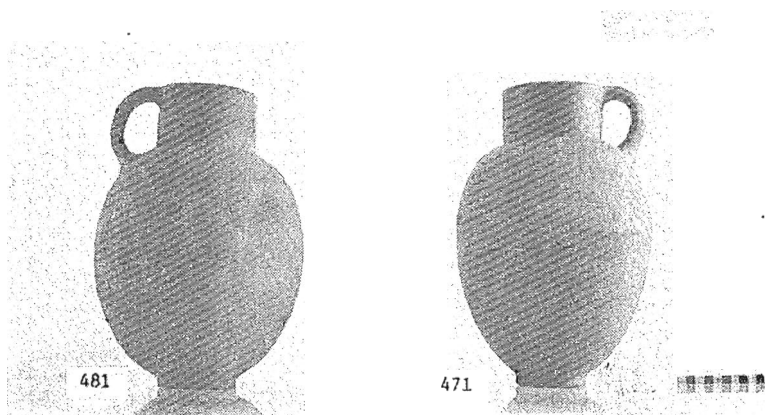

Figure 8



logical and chronological divisions within the Palestinian Iron Age II period. The following parallels appear to be the most significant.

Storage Jars R 1, R 21, R 22

The type is *CPP* 46 P 1-2 at Tell Jemmeh and Anthedon, and of form and fabric found at Level III at Lachish (*Lachish* no. 472, pl. 94—six examples). For this level the *terminus ad quem* is the destruction of Sennacherib in 700 B.C.; but a date for the beginning of the level is difficult to determine. The earlier Level IV is thought to begin about 945 B.C., leaving a probable guess date of about 800 B.C. for III. The example illustrated by Miss Tuffnell has a deeply incised pot mark on the shoulder. At Fara jars of this or of the closely similar types *CPP*, 43 K4 and 46 D2 were found in both inhumation (*Fara* graves 201, 221, pls. XL-XLI) and cremation graves (252-3, 272). Similar jars with bases slightly rounded and offset occur in Level A at Tell Beit Mirsim, *TBM*, I, p. 79 f, pl. 53, 2, close in shape, and *Ashdod*, fig. 98, 4 (stratum 3 b Area D). It appears to be characteristic of south-west Palestinian sites: Sheikh Zuweiyid, Petrie, *Anthedon*, pl. XXXV, and *Gerar*, pl. LV. (*CPP* 46P) where it appears in the Iron II depths at 190-200. The channelled-back handles appear quite distinctive as compared with the ridged-back handles of Mirsim examples. The ovoid jar R 21 has close companions (*CPP* 46N) in graves 1040 and 1140 in the Tell el-Ajjul inhumation cemetery, though its exact profile does not

Figure 9

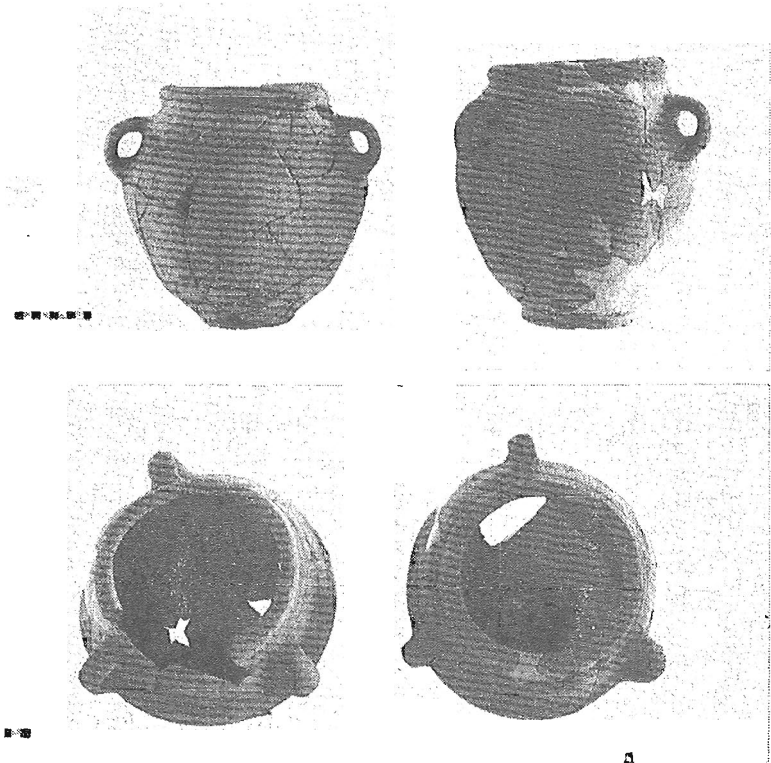

occur there. Ashdod 2, fig. 87, 4 (Stratum 3 b Area D) is close in profile.

Whilst the two jars above fit well into an early Iron II context, R 22 is more difficult. The torpedo-shape storage jar is well established in Iron II, but the specific neck profile is closer to Cypriot White Painted IV jars: Gjerstad *SCE IV*, 2, fig. XLIV, 3. Since it was found without cremated remains or ancillary vessels, it is quite possibly a later intrusion.

Dolia or Hole-mouth Jars R 3, R 12.

These are a long-lasting Iron II type in South Palestine: Reqeish examples are exactly similar to those Iron II at Tell-beit-Mirsim, *TBM*, I, pl. 33 A4, covering the Middle Iron Age. *Burial Jars* R2, R 7, R 8, R 9, R 14, R 17-19.

Tall jars with handle to rim were used in the cremation graves

Figure 10

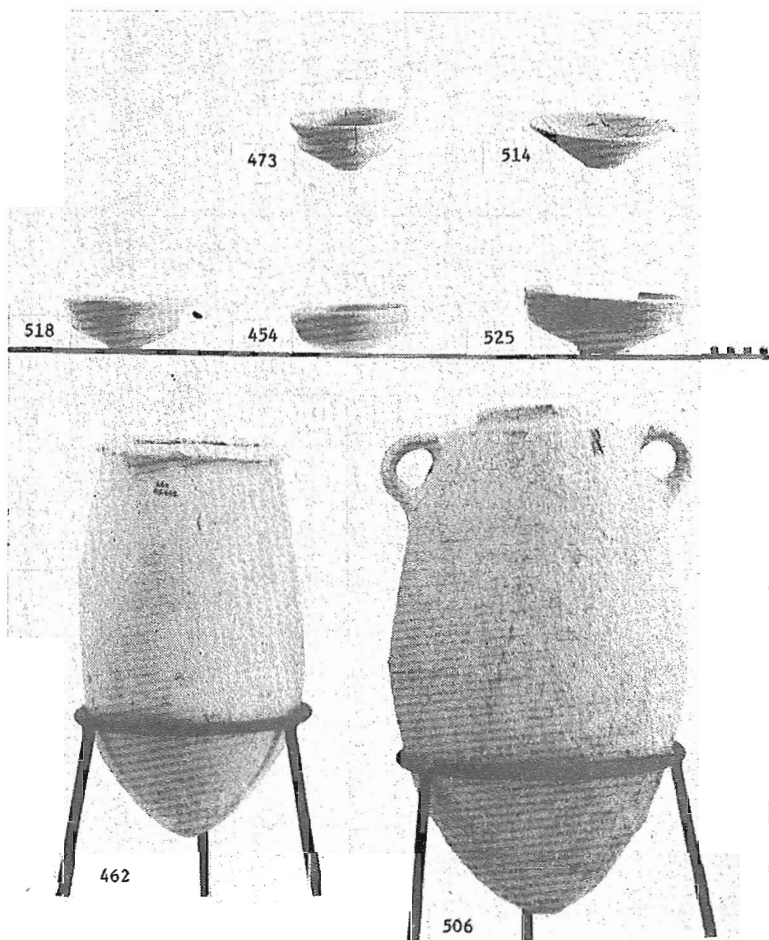

at Fara, *CPP* 33S (graves 223, 256, 299) and 33T (grave 255), which has an incurving neck like Reqeish R 19.

Reqeish 627 is a three-handled jar of unusual type. Another example in *PAM* (Case F. No. 292) comes from Tell Kheleifeh (Eilat). The jars with three handles joined to a medial neck-ridge appear unique and are not recorded at Fara or Ajjul. A red slipped example in the Museum of the American University Beirut (Inv. 59.228) originally came from the Vester collection in Gaza and is probably of Reqeish origin.

Two jars from Iron II at Mirsim, *TBM* III pl. 67, 4, 5 have their necks wider and body profiles as well as fabric are different. Points of likeness can also be made to a jar at Tell Abu Hawam stratum III, Hamilton *QDAP* IV (1935), pl. XIII, no. 79, but what is perhaps more significant at that site is the occurrence in this same stratum, which came to an end about 850 B.C. (by the best indications) of a crater-jar *ibid.*, no. 98, pl. XXXVI with an extremely narrow base, the only parallel I can find to this peculiar feature of the Reqeish jars.

Particularly important for establishing contemporaneity with the Fara cemetery is R 18, which is very similar to the nipples urn from burial 218 at that site, *CPP* 44 W2 and to 33 V2 from burial 250. A jar with lip built up of three ridges (like R 13, R 14 and R 17) is illustrated *CPP* 44 L4 from grave 270 (*Amiran*, p. 291 also notes the likeness), and is obviously close to R 17. The high ridged rims of these jars find their best parallels in Ashdod 3 b (*Ashdod* 2 fig. 41, 22, 26) and a jar neck—not, I think a base—from Ashdod 3 a (*ibid.*, pl. XLVIII, 7) flares out considerably before finishing off with a vertical ridged rim.

Wide mouth jars with three and four handles like R 8 were found in Level E and the cremation cemetery at Hama, P. J. Riis, *Hama, les cimetières à crémation* (1948), figs. 238 A-B, p. 60, fig. 62 in the red slipped and burnished ware typical of the II-IV periods there. In general, however, the Hama jars are squatter and approaching crater-shape. It should not be overlooked that 'Philistine tomb' 532, *Fara*, pl. LXIV contained a jar not unlike the cremation jars in profile, so that local evolution is not ruled out.

Jars comparable to the Reqeish-Fara series are rare in Palestine. A single example from Beth Shemesh (*PAM* 33.1833) has links with R9 in neck profile and flaring rim (*Amiran*, fig. 251; E. Grant, *Rumeileh*, pl. XXI). It is vertically burnished over a deep red slip. Bands of white paint on body and neck link it perhaps with the Phoenician coast, where there are white painted bands on 'local Black-on-Red Ware'. The Beth Shemesh jar appears to belong to the period after the Philistine occupation. Other jars from Rumeileh, E. Grant, *Rumeileh*, pl. XV no. 1105 and pl. III no. 1675 also belong to a red-slip tradition and are vertically burnished whilst another from *Qasile*, p. 65, pl. X, I might be related. Another from Tell Farah, *Revue biblique*, 1951 pl. XIV. 2; fig. 11, 20 has a pink slip with red-brown painted lines. It pre-dates destruction by the Assyrians in the late eighth century B. C.

Crater-shaped Urns R 11, R 15, R 16, R 23, 524.

Craters of various shapes, including the narrow-based crater of Reqeish type and a full-bodied jar-crater have been found in the pottery of Akhziv¹¹ and Khaldeh.¹² *Chapman*, p. 161-2 discusses these and examples from Phoenician sites in Lebanon which were almost certainly used for cremations. It is not possible to suggest 'evolution' of the form or to place the narrow-based crater at the end of a series, since a number of shapes are near contemporaneous at Khaldeh. Quite probably the footed craters like *Chapman*, 211 and 212 are latest. The type is *CPP* 45 KI from Fara, where it appeared in a number of cremation graves. Closely similar 33 U2 is restricted to the cremation graves at Ajjul (1038, 1095, 1135). *CPP* 31 L3, a crater with central neck ridge, was found in cremation 1024 *Ajjul*, pl. XIX.

Their distribution in the south is apparently restricted. A taller version of the crater *CPP* 33U and 33F occurred in burial 251 at Fara. At Ajjul, Tomb 1100 contained 33D2, 33S and 34 U2 (without cremated remains) together with round based dipper juglets and Cypro-Phoenician flasks, and indicates the overlap between the cremations and inhumations there. An example is recorded at Tell el-Hesy, E. J. Bliss, *A Mound of Many Cities*, (1894) no. 299.

Low narrow-based craters (originally a Mycenaean shape) appear to have survived into the Iron II period in Phoenicia, where plain ware examples were used at Akhziv (unpublished). Red slipped and burnished craters appear at Ashdod area D in stratum 4 (*Ashdod* 1, p. 132), which is dated by the excavators to the ninth century B.C., and continue into stratum 4 in the middle eighth.

Phoenician cremation burials at Tell er-Rechidiyeh, south of Tyre, also contained narrow-based craters, decorated in the manner of Cypriot White-Painted II ware; another apparently a local copy of a Black-on-Red II crater.¹³ The crater at 'Atlit, *QDAP* VI (1938), p. 1952, fig. 19 is a poor relation.¹⁴

11. M. Prausnitz, 'A Phoenician Krater from Akhziv', *Oriens Antiquus*, V, fasc. 2 (1966), p. 180.
12. R. Saidah, *loc. cit.*, Nos. 7, 17, 18, 47. The craters from Khaldeh are in all cases deeper and more jar-like.
13. Macridy-Bey, 'A travers les nécropoles sidoniennes', *Revue biblique*, 1904, p. 585ff. One of the craters in the Musée National, Beirut compares with *SCE*, II, pl. CXVI, 8, but with added circles.
14. With this exception, the burials at 'Atlit were made without craters. Johns *loc. cit.*, p. 150 considers that the saucer accompanying this cremation in burial xvii c was sufficient evidence to tie it in with the other eighth century cremations at the site. Its baggy shape is like *CPP* 44 W2-3; it might well belong to a burial later than the rest.

Figure 11

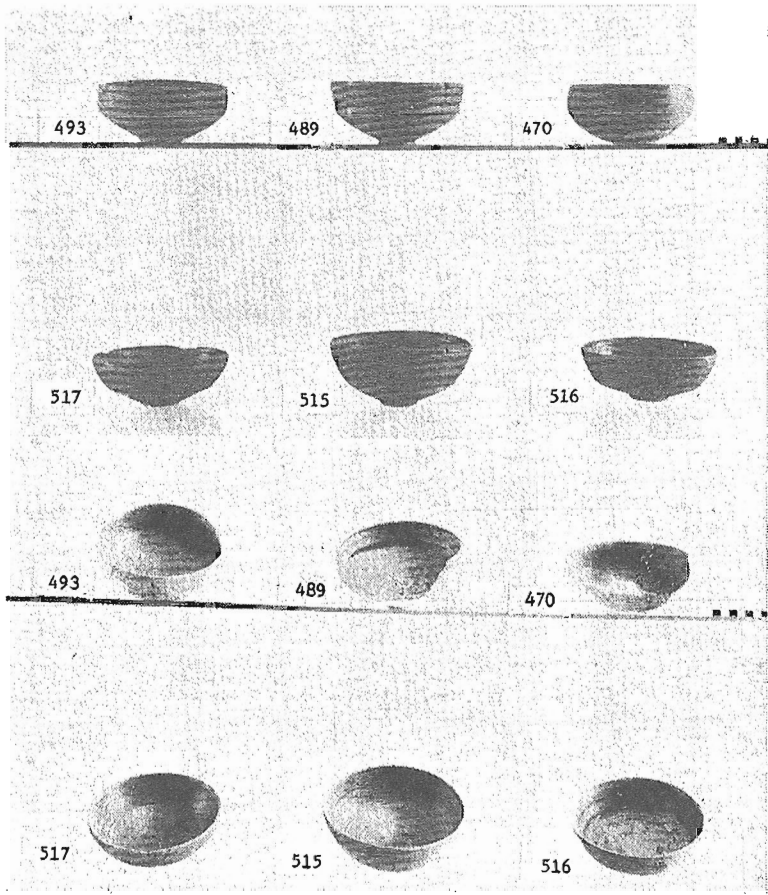

One-handed Pitchers R 6, R 10.

Pitchers with brown hand-burnished slip are present in Period I (ninth century B.C.) at *Samaria*, p. 104, fig. 2, 4, *CPP* 34 U2, 34 U and 35 U2 from Fara are closer to the Reqeish pitchers, particularly 35 U2 with its plain, low, slightly swelling neck. Out of the twenty-seven Fara cremations, ten used ovoid ring-base pitchers—215-7, 219, 264-5, 267-9; and at Ajjul graves 1100, 1134, 1136, 1160 had similar vessels. The type was also found at *Anthedon*, pl. XXIX (JP 382) and XXVI (JP 382-LD280). Local evolution of pitcher forms cannot be ruled out at Fara, since *CPP* 34 H1-M8 types occurred in the Philistine cemeteries

there and provide possible prototypes. Ring-base vertically burnished pitchers comparable to those at Reqeish are confined at Ashdod to the 3a, b and 2 strata of area D and are without prototypes in the Philistine levels there: *Ashdod* 1, fig. 38, 1-2; *Ashdod* 2, p. 99, figs. 41, 26; 46 1-4; 51 1-2. It may be noted that pitchers from stratum 3b have multiple thick ridges on the rim, linking them with Reqeish jars of R 13 type.

The Mirsim pitchers *TBM* I pl. 37, 13-15 are smaller and quite different in fabric. Also they have neck-ridges, linking them with more northerly varieties. Presumably it is this type, occurring also at *Hazor*, pl. LXX 16 in Period VI and found in a single example from Cyprus, *CVA* France fasc. 7, 13,10 which transmits the neck-ridge to Punic pottery (like P. Cintas, *Céramique punique*, no. 91). So far pitchers of both plain neck and neck-ridge types are absent from the graveyards of Phoenicia, though it is noteworthy that the neck-ridge type was used for the much earlier cremation graves in Levels 0 and 1 at Atchana¹⁵ (Fig. 16 d).

Globular disc-top Juglets R 23a, R 6a, R 16b.

The thick, heavy, burnished variety of the Phoenician juglet (R 23a) appears to be commonest on south coastal Palestinian sites and to occur in Deltaic sites in Egypt. Its characteristics, besides thickness, are its ogival neck, without pronounced neck-ridge, and small ring base. In contrast to other types of Phoenician juglet the upper handle dips considerably before joining the body. It is totally absent from Akhziv, Khaldeh and Khirbet Selim material.

As well as occurring with the Fara burials (*CPP* 83 H3) it occurs at Hesy, Petrie, *Tell-el-Hesy* (1891), pl. IX 198 and E. J. Bliss, *A Mound of Many Cities*, no. 239, and at Sheikh Zuweiyid, *Anthedon*, pl. XXXVIII (here fig. 15b). At Tell Jemmeh, *Gerar*, pls. XLVII, LX, both types appear and are common in Iron II. The site was excavated by depths, not by normal archaeological strata, yet there appears a distinct gap between Philistine ware and the floruit of these juglets. The two-handled type (R 6a) is found also at Fara grave 251 (*PAM* 318) and at *Anthedon*, pl. XXXVII. *PAM* VI641 from Fara compares closely with the Reqeish two-handled example. Small and less developed juglets occur in Iron II at Mirsim *TBM*, I, pp. 84-5.¹⁶

15. L. Woolley, *Alalakh* (1955), pls. LXXXIX c. CXIV 63.

16. Both single and double handle flasks which appear closely related to these are found in Ammonite and Maobite pottery, apparently a local development which might have something to do with trade between Transjordan and the southwest, cf. R. W. Dajani 'An Iron Age Tomb from Amman', *AJDA* XI, 1966, p. 43.

Figure 12

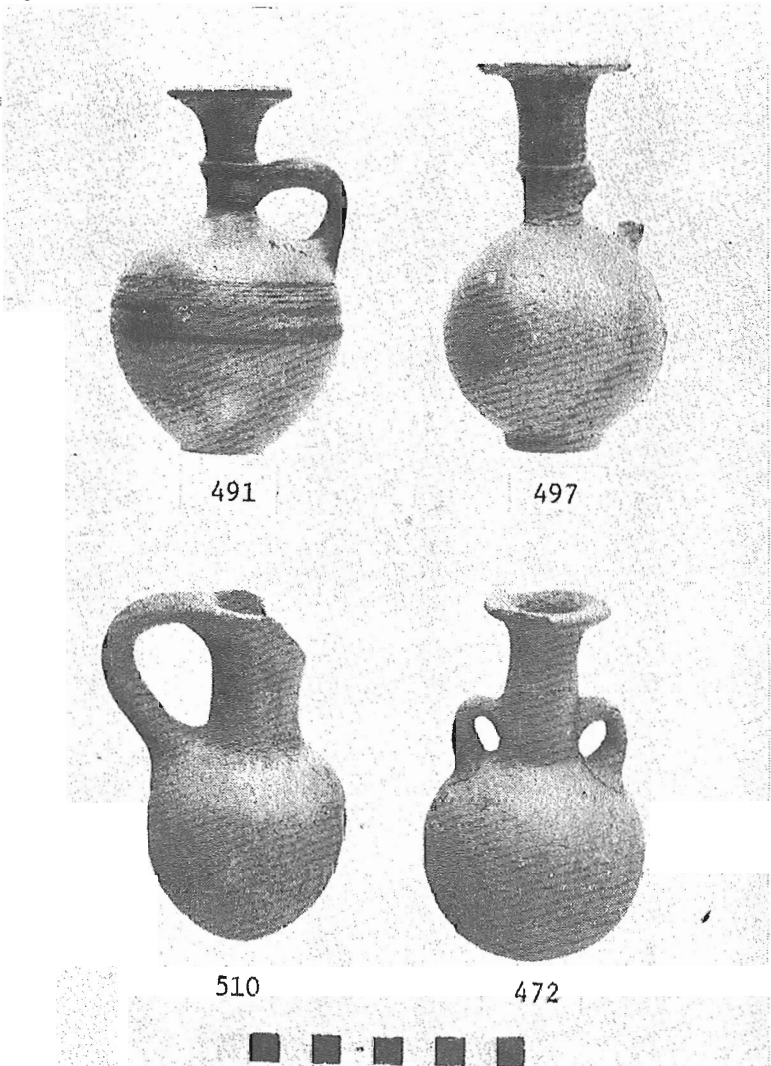

Both type were found at the east Delta site of El-Shagenbeh J. Garrow Duncan in Petrie, *Hyksos and Israelite Cities* (1906), p. 53, pl. XXXIXL 31, 32 (here Fig. 16b). From contexts dated by the excavator to Dynasty XXII and later—"thick heavy red

pots". An example is recorded amongst other 'Cypriot' pottery in the notebooks of the Eckley Coxe Expedition to Mit-Rahine (Memphis University of Pennsylvania Museum) in contexts of the XII Dynasty (Fig. 17D). I have also seen an excellent specimen of a one-handled juglet of this 'heavy type' from N. Glueck's excavations at Eilat, now in the Smithsonian Institution, Washington.

R16b belongs to the 'bichrome burnished juglet' group which has a far wider distribution, though with many varieties of detail and finish. Juglets from level VIII at A1 Mina are close (Fig. 16a)¹⁷ though the rims are cut square and turned downwards. The upward-thrust rim is typical of Cyprus (*SCE*, IV, 2 fig. XXII, 5a), but shape and fabric are not Cypriot.

This is especially shown by the two examples from a grave-group at Skarinou in Cyprus.¹⁸ They are 'bichrome burnished' and doubtless imported. The context is with Black-on-Red II and Bichrome IV, which suggests their currency in the seventh century B.C. Probably the closest parallel is *Anthedon*, pl. XXXVIII, 84 HI. A lower terminus is in any case provided by the Assyrian occupation, which at Gerar is evidenced by the distinctive Assyrian pottery *Gerar*, pl. XLV.

Black-on-Red Juglets R 1b, R 11b, R 13a, R 16b.

The small Black-on-Red juglets R 1b and R 16b are virtually identical and belong to Black-on-Red I (III) of the *SCE* classification. They are common in the Achziv graves but rare at Khaldeh. It is well known that their origin and initial date pose a problem, but evidence seems to be mounting that they last into the eighth century B.C.¹⁹ They were common accompaniments of the cremations of Ajjul²⁰ and Fara and occurred in the collective Tombs at the latter. R 11b has the broader base more typical of Black-on-Red II (IV) (*SCE*, IV, 2, pl. XXXVIII, 3a).

-
17. J. du Plat Taylor, 'Syrian and Cypriot Pottery from Al Mina', *Iraq*, 21 (1963), p. 69, fig. 2, 9-11; pl. XXb, where parallels in shape are listed. The Al Mina juglets are heavier and smaller than their equivalents from Akhziv and Khaldeh.
 18. 'Une tombe archaïque a Skarinou', *BCH*, 84 (1960), p. 295, fig. 72, b.
 19. J. Birmingham, 'The Chronology of Some Early and Middle Iron Age Cypriot Sites', *AJA*, 67, 1 (1963), p. 36.
 20. Graves 1010, 1011, 1022, 1037, 1067, 1074, 1106, two examples being of the two-handled type, which is thought to be later than the one-handled.

Figure 13

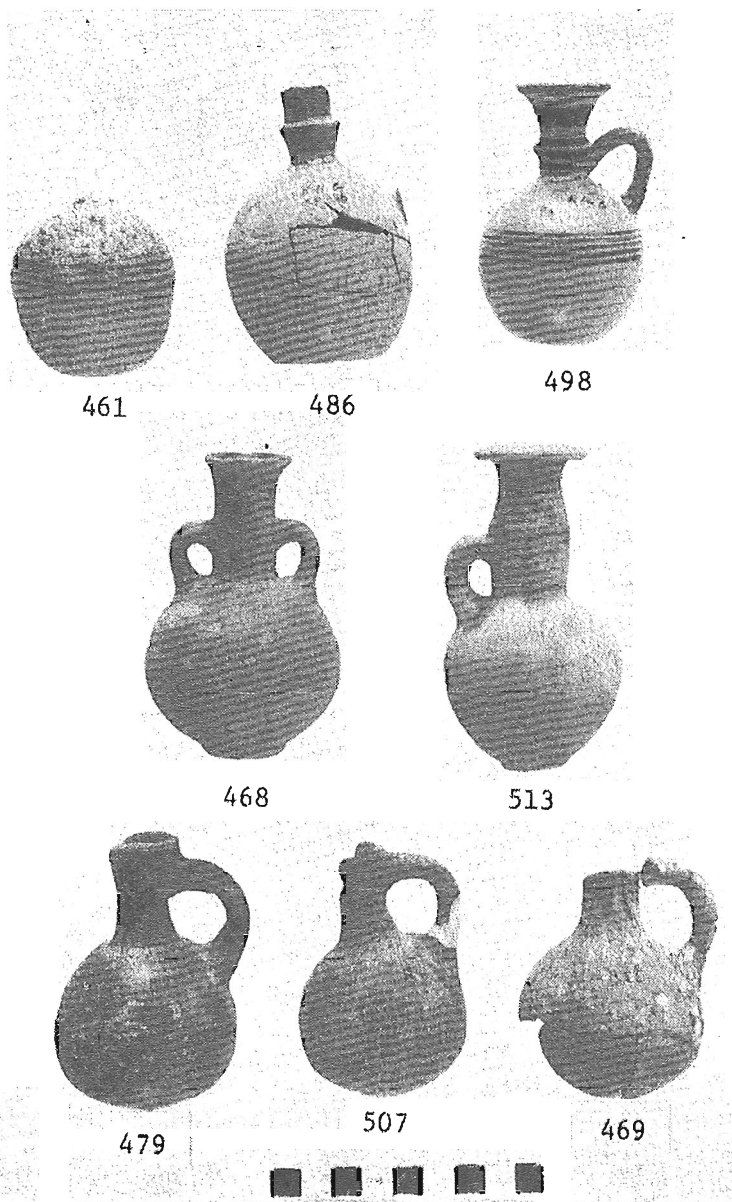

Chalices R 3a, R 4, R 10a.

Small 'chalices' were apparently placed in the Joya tombs in the Lebanon (*Chapman*, p. 114), at Fara in grave 213 (*CPP* 17 Q2); and there is an unpublished example from tomb 501 at Akhziv. The larger examples from Reqeish belong to a type well distributed but not common in coastal sites and in the south: *Qasile*, p. 135, fig. 6 from stratum X and H. W. Hamilton, Tell Abu Hawam *QDAP* IV, no. 88, both giving ninth-tenth century dates. The exact equivalent to R 3a is *Halif*, p. 338, belonging to the earlier group of material from that tomb. Both at Fara and Gerar the type with stepped foot is well represented *Gerar*, pl. LIX, 92 c-q. At both sites it is likely to have evolved from the painted and lotiform 'chalices'. According to Miss Tuffnell's conclusions, *Lachish*, p. 218, the type with stepped foot does not extend later than 800 B.C. No example appears to have the curvature and neat rim of the bowl of R 4: earlier types from *Gerar*, pl. LIX, 17 e and j are closest, and if Miss Tuffnell is correct in placing curved-bowl chalices earlier than those with angular profile, a date in the mid-ninth century appears most likely for R 4.

Carinated Bowls with flaring rim, R 6b, R 28.

These occur in the other southern sites: four examples in *Fara* grave 246; *Ajjul* grave 1100; and *TBM I* pl. 64, 6, 9, 16, where they are included in the 'ring-burnished' class of Iron II. *Halif* bowls p. 33, fig. 1, 3 are close. Bowls of similar shape and decoration occur in strata 3 and 2 in Area D at Ashdod: *Ashdod 2*, fig. 39, 11, as well as examples with plain flat bases, *Ashdod 1*, p. 134, fig. 37, 1-4. Dothan remarks on the rarity of bowls of this type. An excellent example from tombs at Azor apparently dates back to the tenth century B.C.: M. Dothan, 'Quelques tombes de l'Age du Fer Ancien à Azor', *Bull. de la Société d'Anthropologie*, XI (1961), p. 80.

Further north they are rarer. They do not appear amongst extant material from Phoenicia proper. There appears a single specimen with a ring-base at *Samaria*, p. 115, fig. 6, 5 in finer ware from Period IV. At Nasbeh there are earlier and coarser examples of the ninth century extending down into the eighth: J. C. Wampler, *Tell-en-Nasbeh*, II (1947) pl. 55, 1239, 1243. *Hazor*, pl. LII, 1 has them in stratum IX (first half of the ninth century) though coarser. After this stratum they develop thickened or turned rim and lose the ring-base.

Bowls of this shape have been found in the Phoenician West:

G. Bonsor, 'Les colonies agricoles pré-romains de la vallée du Bétis', *Rev. arch.*, 1899 figs. 164, 162.

Hemispherical Bowl R 5c, Fig. 11, 470.

These appear to be a deeper version of the shallow round-based bowls in Samaria ware, *Samaria*, figs 10, 19. Deeper examples, completely slipped and burnished or with reserved bands, appear to be characteristic of Phoenician pottery in the Iron II period. Usually the sides straighten out and can be almost vertical. For an example from Phoenicia cf. *Chapman*, no. 152: an example from Akhziv here Fig. 16; P.L.O. Guy, *BSAJ Bull.* 5, 1924, pl. 3, 25 from a tomb on Mt. Carmel. J. du Plat Taylor, Iraq, XXI fig. 6.4 illustrates one from Al Mina. In *Hazor*, pl. LXVII, 3 they are illustrated from period VI, and on p. 17 said to occur earlier amongst 'Samaria' bowls. The type is *Lachish*, 94, pp. 272-3, where it is closest to ninth century B.C. types. There is one example from Ain Shems, Grant, *Ain Shems Excavations*, pls. LXIII, 6; XLII, 28. There are a number from stratum 3 in Area D at Ashdod, *Ashdod 2*, fig. 37, 9, 10 and pls. XL14, XLV2, this latter close to the Al Mina examples. In fine ware it occurs in Megiddo period IV, Lamon and Shipton *op. cit.*, pl. 28, 95.

At Fara cremations 256, 257 and 270, *CPP* 23 J. 12 contained bowls of this type and there is one from inhumation 229, *CPP* 24 Z2. At *Ajjul* one occurs in cremation 1135. The type is well represented amongst west Phoenician pottery, particularly at Motya.

Bowl with the grooved rim, R 12a.

CPP 18 FA, 18 D, 18 E, illustrates many from the 200 cemetery at Fara. Many have vestigial horizontal handles: presumably it derives initially from the grooved bowls listed in the 500 cemetery there. *Lachish*, pls. 79 nos. 22, 24, 28; 99 no. 597 provides good parallels to the handle-less type. There can be no doubt there that they are predominantly of the tenth century B.C. and run more or less parallel to the equivalents with knobs or bar-handles: *Lachish*, pl. 18 nos. 103-4. Their range at Ashdod is strata 3a, 3b, *Ashdod 1*, p. 135, fig. 37, 12 and *Ashdod 2*, p. 95, fig. 37, 16, to which the date currently assigned is probably too low. Other examples are: F. J. Bliss and R. A. S. Macalister, *Excavations in Palestine 1902* pls. 55, 3; 21, 4 from stratum II at Tell el-Judeideh (i.e. *CPP*, 18 El and *Amiran* fig. 218) and W. J. Pythian Adams, *PEFQS*, 1923, pl. 2.1 from Ascalon.

Figure 14

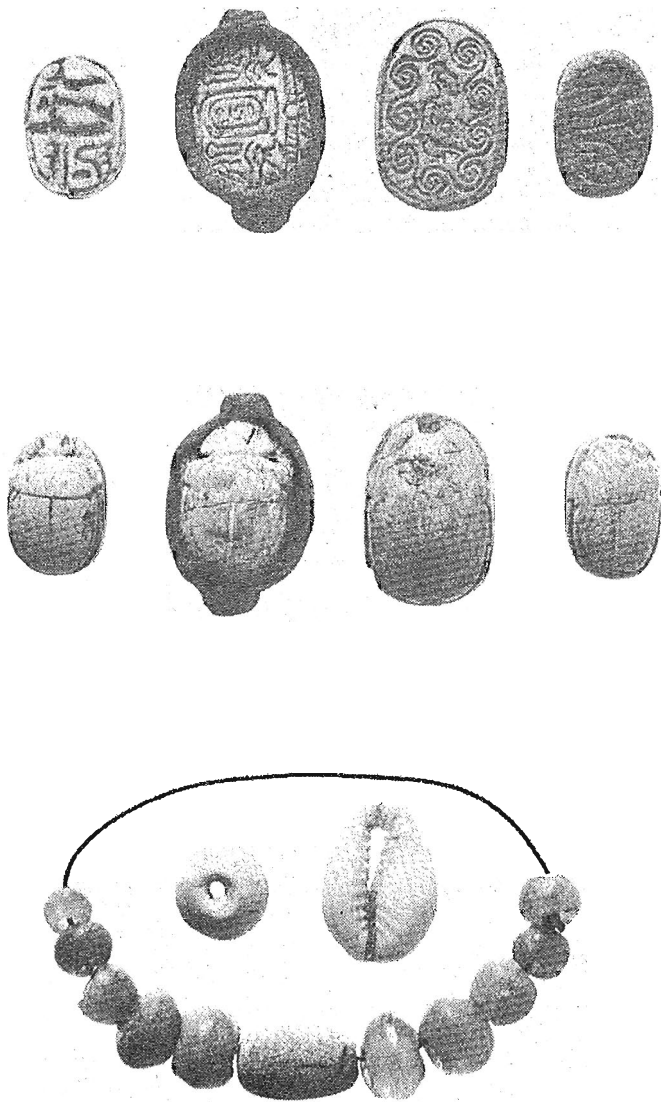

Above: Scarabs 456, 502, 503, 457.

Below: Globular blue glass bead, carnelian beads and cowrie shell (458).

In Fara grave 534 it occurs with pitcher *CPP* 34 X 4, showing the continuity of graves in the 500 and 200 cemeteries.

Conical Bowls R 24.

Coarse conical bowls with flat bases occur in the 'Atlit graves of the eighth century, Johns, *loc. cit.*, fig. 6, 5 and amongst Phoenician material from Khirbet Selim, *Chapman*, no. 239. It is a type not particularly common in Palestine. *CPP* 12 L4 gives an example from Ajjul grave 95, a near contemporary of the cremation graves there.

Dipper Juglets R 2a, b, R 3b, R 8a, R 9a, R 10b, etc.

Twenty-nine dipper juglets were found in the Fara cremation graves. They are *CPP* 53M and 53P1 (which has lower profile rather like R 15b). Though Petrie does not specify, they appear to be of the round-mouthed variety which are regarded as having taken over from the pinched-mouth in the tenth century B.C. The pinched-mouth dippers *CPP* 50 C3 and 50 N2 certainly do not occur in the Fara cremations, whilst round-mouth types were beginning to appear in the larger collective burials of the 200 cemetery. It should be noted that round-mouth *CPP* 52 P2 already appears in grave 527 at Fara. R 10b (510) has parallels in stratum 3 at Ashdod, *Ashdod 1*, pl. XXV, 2 fig. 37- 25 and is rather like Anthedon types (Fig. 15a). The other juglets, and especially the black hand-made juglets are of common types which have a long life in Iron II Palestine.

Bowl with straight sides sloping slightly inwards, R 13c.

At Fara the type is closest to *CPP* 18 R2 from cremation burials 257, 270. It appears to be rare. A close parallel in shape and burnish comes from Ashdod 3b, *Ashdod 2*, pl. XLII, 4. The Fara specimens, to which we may add *CPP* FL1 from graves 223 and 256, have more vertical sides. Generally it seems very close to the following bowl type.

Carinated bowl with straight outward sloping sides, R 1a, R 26.

An example with ring base is *Samaria*, p. 109, fig. 4, 10 from Period III there. It has parallels in stratum V at Megiddo, R. S. Lamon, G. M. Shipton, *Megiddo I* (1937), pls. 28, 97-8; 30, 126 and (less close) in stratum III at Tell Abu Hawam, Hamilton, *loc. cit.*, no. 69. *CPP* 16 illustrates many analogies, 16 W from *Gerar*, pl. XLIX being closest and found at 180-190 depths at that site, equated with the ninth century B.C.

Hemispherical bowl with rim and ring base, R 25.

Difficult to parallel. A close relative occurs at *Ashdod 2*, figs. 37, 13; 39, 16.

Bowl with flat bottom and flaring sides, R 11a.

CPP 13D from Iron Age levels at Gerar might be the type, though the base here appears rounded. *Chapman*, no. 153 from Khirbet Selim is rather similar but less fine. Apparently a rare shape.

As can be seen from the above comments, the links are close between the pottery forms of the Reqeish, Ajjul and Fara cremation burials. Clearly also, at Fara the cremation graves are later than the majority of graves in the 200 cemetery, though they might overlap with the large collective tombs 201, 202 and 229, etc.

At all three sites Black-on-Red juglets were especially associated with the burial urns; and although this is not exclusively the case at Gaza or Fara, it is remarkable how predominant the association is. The round-mouth juglet CPP 83, H2 occurs at Gaza in a cremation grave 1135 and the crater is found only in cremation 1024. At Fara the small juglet CPP 83 B3 is exclusive to cremations as is the heavier 83 B1. Similar types certainly appear with the inhumations, but rims and handles appear to be less well developed in most cases. The pilgrim flasks found in some inhumation graves are entirely absent from the cremations, as are the Cypriot barrel juglets. Both have chronological precedence over the Black-on-Red juglets. (Birmingham, *loc. cit.*, p. 29.)

Only one Philistine vessel is reported from the Fara cremations: the strainer jug from burial 268 (CPP 67 D2) quite possibly intrusive or misrecorded. In fact the 200 cemetery as a whole contained only one other distinctively Philistine vessel—CPP, 34 Y3. Otherwise its links with the Philistine cemeteries seem closer to the 500 cemetery, with which it shares a number of types: it is not impossible that some 500 graves overlap the 200 groups. But links with earlier Philistine graves are few and consist mostly of the painted chalices illustrated in CPP 17 H and the grooved-rim bowls with miniscule handles. The former are a rather tenuous link with the Philistines and it must be noted that typologically and decoratively their development elaboration takes place almost exclusively within the period of the 200 cemetery. The bowls in question well outlast the Philistines.

Certainly none of the cremation graves at Fara was accompanied by material extending back into the tenth century (apart, that is from the Philistine jug noted above). And if a date of circa 1000 B.C. is correct for the incipit of the larger tombs at Fara, *Fara*, pls. XXXVIII-XLI, the only ones illustrated by Petrie (Birmingham *loc. cit.*, pp. 38, 39 *Samaria*, p. 205), and if, as seems likely, chalices like Reqeish R5 are developments from the painted Fara chalices, it seems logical to place Reqeish later in the timespan of the 200 cemetery, especially also as the R1 storage jar, well post-1000 B.C. at Lachish, is more sophisticated than its equivalent illustrated by Petrie in graves 201 and 229 at *Fara*, pl. XXXIX-XL.

How late, then, did Fara 200 last? It may be supposed that here and other southern sites the Assyrian occupation brought some demographic changes. Although Prausnitz (*loc. cit.*, p. 185) appears incorrect in regarding the 600 cemetery at Fara as a terminal date for cemetery 200 on the grounds that it is Assyrian—it is in fact Philistine with some Achaemenian graves—there is none of the Assyrian pottery as at Tell Jemmeh—occupation of Fara seems to be well over by the late eighth century. Petrie himself dated grave 226 on scarab evidence to Sheshonq III, *Fara*, p. 13. The scarab seal which he illustrates from grave 228, *Fara*, pl. XXXV, 427 is a Phoenician type whose script and style can scarcely be dated before 800 B.C.²¹ Clearly some of the tombs are post-Solomonic. Without reconstructing the new scattered tomb material it would be hazardous to suggest the maximal date range. The material from the 200 cemetery is said to have a certain homogeneity, and a duration from 1000-800 B.C., or perhaps lowering the initial date to 950, which would not do particular violence to anything that can be proved, is the best that can be suggested. Certainly little claim can be made that the eighth century is represented there. Leaving aside the cremation rite as an insecure cultural criterion, the break in the Fara cemeteries is more clearly pronounced between the Philistine period and Iron II than it is between the inhumation and cremation graves of the 200 cemetery. The same holds for the few cremation graves at Ajjul which appear to be contemporary with the later graves of the Iron II sequence there. It is, of course, a matter of guess-work as to how long that break was. It is reasonable to suppose that after the suppression of the Philistines, the expan-

21. K. Galling, 'Beschriftete Bildsiegel des ersten Jahrtausends v. Chr.', *ZDPV*, XLI (1941), p. 131, No. 7, assigns it to 900-700 B.C. on archaeological grounds, but it is most unlikely that its script dates before 800: in fact the script of a Hebrew seal dated to the eighth century is close, I. Ben-Dor, *QDAP*, XIII (1948), p. 90, pl. XXXIII.

Figure 16

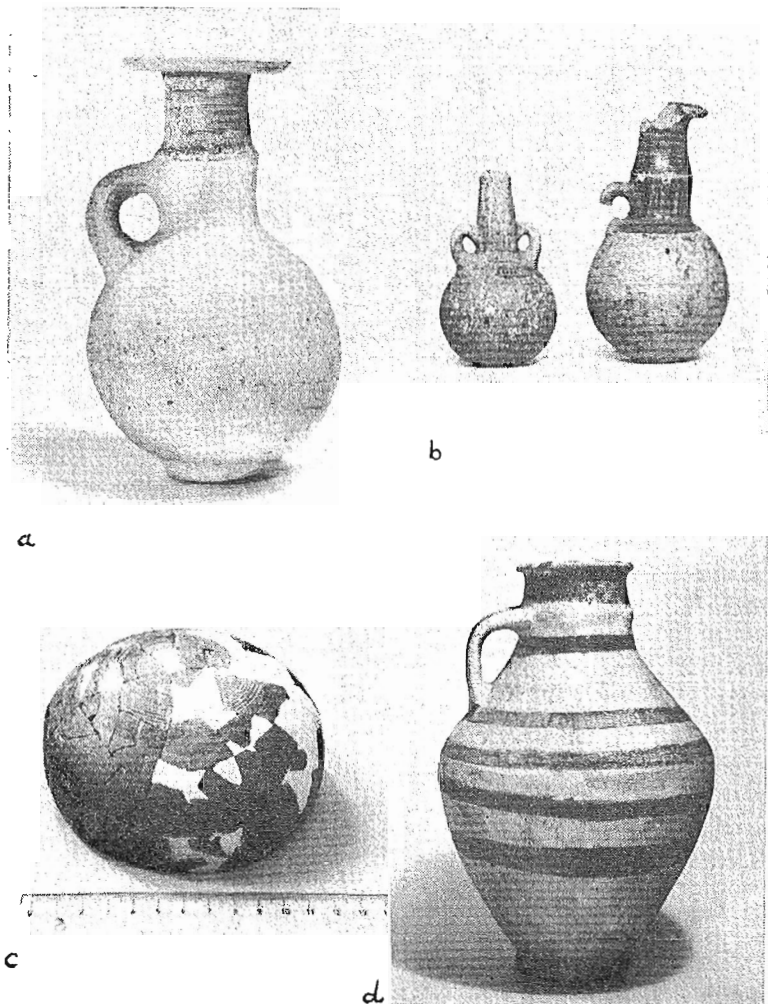

- a. Juglet from Al Mina, Ashmolean Mus. Oxford, ht 14 cm.
b. Pottery from El Shaganbeh, Ashmolean Mus. Oxford.
c. Bowl from Akhziv, Palestine Arch. Mus.
d. Pitcher from Atchana, Ashmolean Mus. Oxford.

sive economic conditions under Solomon led to reoccupation fairly soon. Apart therefore from the scarab evidence, which after all only give *termini post quem*, I see no reason to begin the major part of the 200 cemetery before 950 B.C.

The Reqeish scarabs are no help in dating and belong to the archaizing Hyksos scarabs found in many XXth Dynasty contexts. they are:

- R 2a (456) Pale blue paste. Ouser-mast-Re-setep-en-Amun, the throne name of Ramses II.
- R 2b (457) Bluish white paste with engraved designs of three lotus blossoms between lotus leaves.
- R 19a (502) Royal cartouche of Ra-aa-kha (dyn. XV) flanked on each side by *Was* sceptre, flower bud and *oudjat* eye. Below is the solar disc with outstretched wings. Cf. A. Rowe, *Catalogue of Scarabs in the Palestine Museum*, p. 38 ff.
The cut and layout are paralleled in scarabs of the XIV-XVI Dynasties, Petrie, *Scarabs and Cylinders with Names*, 1917 pl. XX, 4W, XXi, 12 a and 1.
- R 19b (503) White paste. Running spiral enclosing a design of two falcons with between them, vulture holding *ankh*.

Whilst it is quite clear that the pottery of these south Palestinian cremation graves is quite distinct from that of the Philistine ambience of Iron I, its precise position within the Iron II period is not easy to establish. Though plainly related to the pottery of Tell Beit Mirsim and Lachish, it nevertheless has a distinctive flavour. This is not the pottery of the Hebrews and these are not Hebrew burials. The coastal pottery of Iron II and Tell Abu Hawam, Qasile and Ashdod is generally quite different, though specific links with both sites have been pointed out. Ashdod is the nearest well stratified site, but appears to have had a considerable continuum of pottery types in the early Iron Age. The technique of hand burnishing in bold strokes on red slip comes in the tenth century B.C. on 'Ashdod Ware' after the Philistine decline, and continues common down to the end of Ashdod 3b, which on present theory (*Ashdod 2*, p. 21) extends between destruction levels attributed to Uzziah and Sargon II. At present, however, the sequence between Philistine decline and the mid-eighth century at Ashdod is very fluid; and if in fact the 3b stratum is as narrowly confined historically and as short as the excavators at present suggest—which I doubt—one must not over-

Figure 15

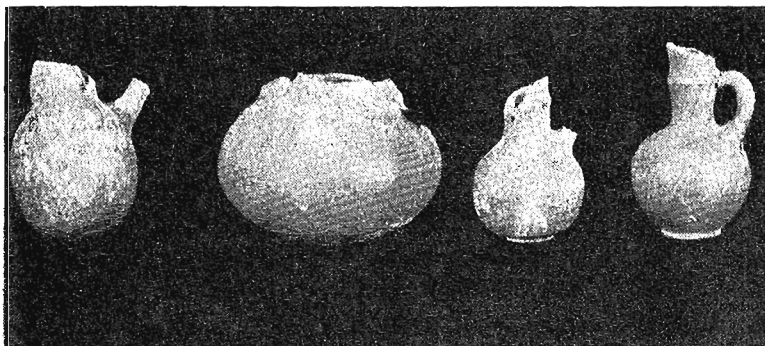

Juglets from Anthedon (Australian Inst. of Archaeology).
1A 4.11 ht 8.7 cm; 1A 4.13 ht 8.9 cm; 1A 4.15 ht 9.1 cm.

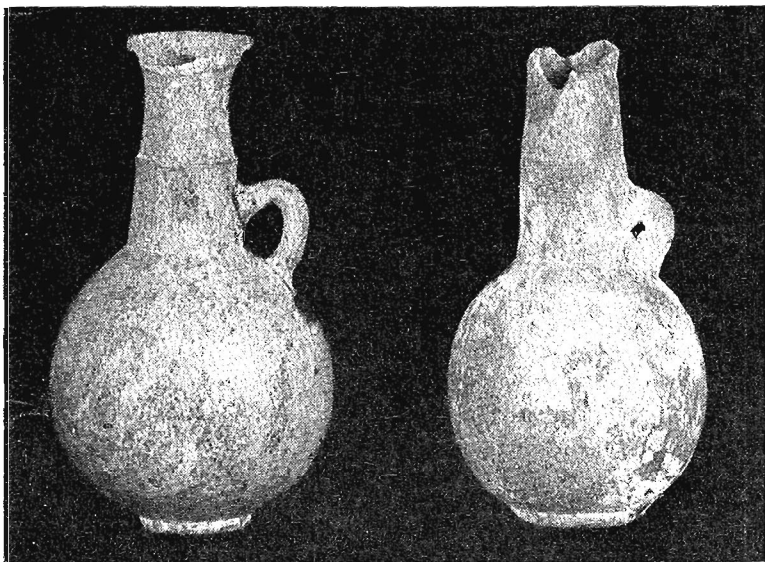

Flasks from Anthedon (Australian Inst. of Archaeology).
1A 4.08 ht 16.9 cm; 1A 4.08 ht 16.4 cm.

look the probability that many 3b types were developed before that stratum. Certainly the comparisons between Reqeish and Ashdod 3b types are insufficient for bringing the former site down to the eighth century on Ashdod evidence alone. A date about 850 B.C. would be most suitable for Reqeish. It must also be pointed out that although the same burnishing techniques exist

at Reqeish, the fabrics and finishes there are very different from those of 'Ashdod ware'. The Black-on-Red painted design of Ashdod ware is absent from Reqeish, Fara and Ajjul alike. On the other hand, the predominance of hand-burnish at Reqeish is not in itself a guarantee of early Iron Age date, since Dothan has remarked on the occurrence of both hand- and wheel-burnish at Ashdod 3b. Both occur on the Reqeish bowls.

Inland in the Beersheba region, Tel Halif has yielded a little comparable material. In addition to three Black-on-Red I juglets, *Halif*, pl. 37D and small black juglets *ibid.*, pl. 37, C the tomb contained a large pitcher with handles joining on to neck ridges *ibid.*, fig. 6, 5 of white ware painted with red bands; together with red burnished piriform jug. *ibid.*, p. 34, 8 close to metropolitan Phoenician ware. A number of the smaller hand-made juglets are also red-slipped and burnished. The contrast in this tomb between the bowl types of the deposit and those of the burial chamber proper (*Halif*, p. 33) quite clearly aligns the Reqeish bowls with material of the tenth-ninth centuries B.C. rather than with the date of the final use of this tomb which the excavators place in the late ninth or early eighth centuries by adequate parallels.

A further indication for continuance of Fara into the ninth century is provided by the Palestinian type cooking pots in use in the 200 cemetery. One of these was used to hold cremated bones (burial 257); two others were used as covers for urns (burials 251, 265). All three are of the 'late shallow type', *CPP*, 32 D3; which is regarded as having come into use in the middle of the ninth century B.C. and continuing down to the fall of the Southern Kingdom in 587 B.C.²² Shallow cooking pots were also used to hold the cremated remains in graves 1151 and 1153 at Ajjul.

We may add the bowl-type *CPP* 20K, not represented at Ajjul or Reqeish, but found in cremation 259 at Fara. It is a slope-sided bowl with ring base splayed outwards and rim interned at a high carena. They are common at Mirsim, *TBM* I, pls. 62A nos. 16, 20; 63A, 8 and belong there to the spiral-burnished class of Albright's Early Iron II (i.e. ninth-seventh centuries). They are not quite so common at Lachish, but compare the one found in Level III (Locus H 14:1002) covering the eighth-seventh centuries, *Lachish*, pl. 79, 44.

Tradition of red slipped hand-burnished pottery can now be seen at least in south coastal Palestine, to have emerged at

22. Y. Aharoni and R. Amiran, 'A New Scheme for the Sub-Division of the Iron Age in Palestine', *IEJ*, 8 (1958), pp. 171-184.

Figure 17

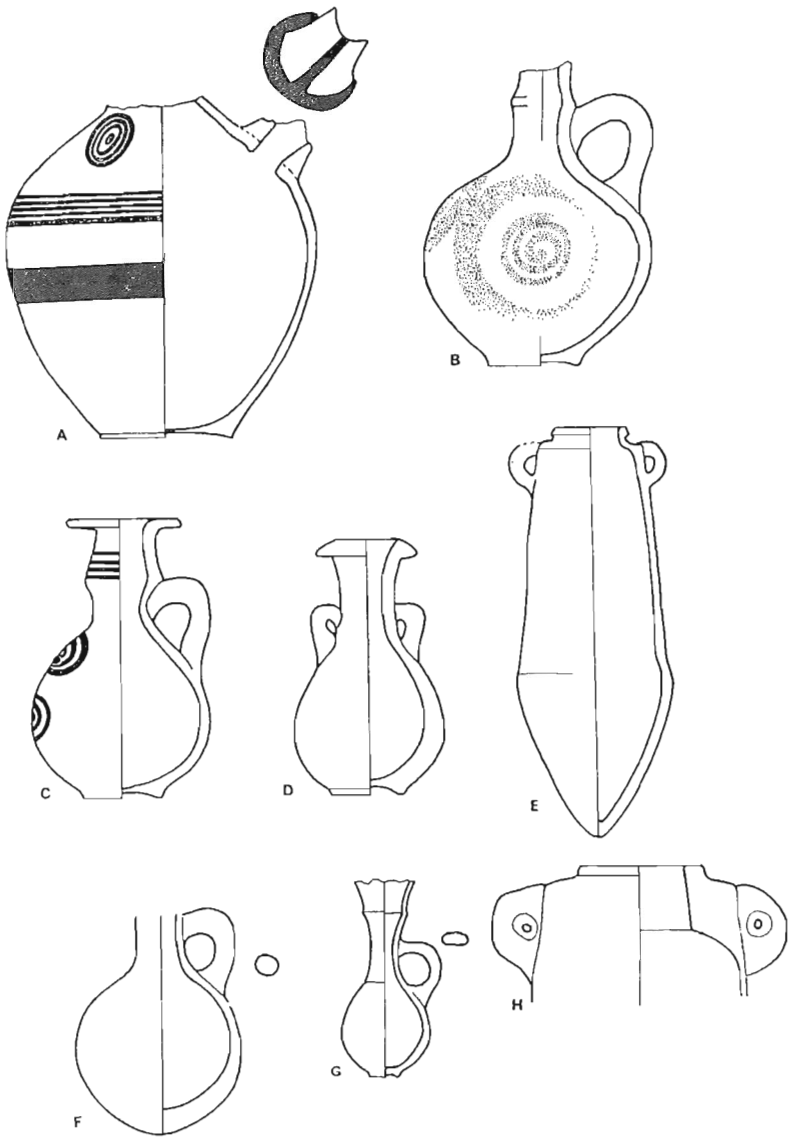

Pottery from Mit-Rahine, Memphis. Not to scale.

the end of the Philistine period. With one exception amongst the published material from Ashdod, the fabric and burnishing technique of the 'Ashdod ware' is different from and less refined than the group of red-slipped and burnished jugs which unite Khaldeh, Akhziv, Khirbet Selim and Byblos (*Chapman*, pp. 40, 62). The characteristic pieces are piriform jugs with double-cordon handles, bell-shaped jugs with disc-tops (*Chapman*, p. 82) and thin 'Samaria ware' plates and bowls. It appears from these four sites possible to define red-slip types typical of Metropolitan Phoenicia, some of which is characteristic in Cyprus of 'Phoenician Red Slip Ware'.²³ (Red Slip II (IV) of Gjerstad's *Swedish Cyprus Expedition* classification.) This does not occur in the Reqeish graves and is poorly represented in the south. A jug from the 1122 cremation burial at *Ajjul*, pl. XXI, 39 M6, might possibly represent it: otherwise it occurs only in *Gerar*, p. 22, pl. LX, 83m (a bell-shaped jug with angular profile from a level dated to the XXVIth dynasty), in very small quantity at Ashdod, and probably in the jugs from *Halif*, figs. 16, 18. The refined jug from tomb 201 at *Fara* (*Fara*, pl. XXV, 39NI) looks as though it might belong to jugs of the Red-Slip family, but is of a burnished pink-buff ware (Ashmolean Museum, Oxford). Strictly therefore these cremations lie outside the main Phoenician ninth century ambience culturally if not chronologically.

Yet a broad interesting question is raised by these cremation cemeteries: does cremation itself or, indeed the mixture of burial practices, indicate the presence of Phoenicians? Or is cremation merely a temporary variation of local custom? Neither Philistines

23. Mrs. Birmingham, *loc. cit.*, p. 25, followed by *Chapman*, p. 181, adopts a date in the mid-ninth century for its appearance, or, more precisely, for the appearance of the shapes and fine buff-orange fabric hitherto commonly recognised in Phoenicia and Cyprus—piriform jug, jug with tall neck and pedestal base (*Chapman*, No. 261) and the bell-shaped disc-topped jug (*Chapman*, No. 300). That it was preceded by a coarser type of red-slip ware sometimes decorated with black painted lines and now called 'local Black-on-Red ware' is emerging as a distinct possibility—cf. Prausnitz, 'Red-polished and Black-on-Red Wares, etc.' (quoted in n. 4), p. 134, where a date at the end of the eleventh century (probably too high) is suggested for the appearance of the 'local' at Achziv, followed somewhat later by the piriform jugs, etc., in finer ware. This local Black-on-Red might well be diagnostic of a northern phase parallel to 'Ashdod Ware' in the south and contemporary with various types of Phoenician bichrome ware. Reqeish ware might be yet another offshoot of it.

nor Hebrews practised it.²⁴ It is now well attested in Phoenicia and her dependencies, where inhumation and cremation were practised together, often in the same tomb. Our present evidence does not, however, show unequivocally that cremation is to be associated with Phoenicians: at Hama, Yunus²⁵, as well as at Atchana, where it appears earliest in the coastal region, there is no strict evidence that Phoenicians were involved.²⁶ Yet the relative cultural isolation of Hama E and Yunus together with a few contacts with Phoenician pottery (either in the form of imports or techniques) at both sites suggests that these might represent small colonies of Phoenician traders (like those at Al Mina) who had formed a local sub-species of Phoenician pottery. After all, whilst Phoenician colonization turned to the West, trade expansion turned to the East as well.

At neither Ajjul nor Fara was the period of the Iron Age graves significantly represented on the mound, a factor again suggesting that at some time after the Philistine decline these places had been reinhabited on a different pattern. It is not impossible that with the permission of the Israelites metropolitan Phoenicians, bringing with them the practice of cremation burial and developing a local facies of the culture of Tyre and Sidon, were allowed to participate in the overland trade with Arabia in Solomon's time, and that the Reqeish cemetery belongs to a later phase of this trade, perhaps in the time of Jehoshaphat.²⁷ If, as I believe, the 'chalices' of Reqeish type (or 'braziers' as they are called in *CPP*) and their lotiform forerunners at Fara are incense-

-
24. In Philistia the earliest recorded example is at Azor, M. Dothan, 'Excavations at Azor 1960', *IEJ*, 11 (1961), pp. 171-5. Cf. for photographs, Nos. 43 and 44 of *The Philistines and other Sea Peoples*, Israel Museum Exhibition (Winter, 1970). The cremated remains were buried in a storage jar with oblique shoulder and ridged rim, a type which makes its appearance at Hazor VIII, *Hazor*, pl. LIX, 8, and at *Qasile stratum X*, pl. 26, 2. The juglets which accompanied it are clearly equivalent to those of stratum X, *Qasile*, pl. 28, 1-3. It is therefore post-Philistine.
25. L. Woolley, 'The Iron-Age Graves of Carchemish', *LAAA*, XXVI 1-2 (1939), p. 11-37.
26. The phenomenon of cremation in Palestine and Syria during the Iron Age is fully discussed by P. J. Riis, *Hama les cimetières à cremation* (1948), pp. 36-45.
27. For trade with Ezion-geber under Jehoshaphat cf. N. Glueck, *BA*, 3, 4 (1940), p. 54 and *BASOR*, 79 (Oct. 1940), p. 8.

stands,²⁸ they illustrate the incense trade which was part of the *raison-d'être* of these trading colonies. That their pottery reached Egypt in the XXII Dynasty is evident from the finds at Mit-Rahine (Fig. 17). Meanwhile southern Judaeen cities like Lachish and the old Philistine centre at Ashdod developed their own respective Iron II facies which has in fact less connection with Phoenician culture than Reqeish, Ajjul and Fara. The economic importance of the Gaza region to the Assyrians has recently been stressed:²⁹ considerable warfare, evacuations and the planting of foreign colonies took place in there, though Ashdod and Gaza lived on.

This Phoenician landward 'diaspora' is put forward here merely as a hypothesis: whilst the material culture of the Iron II period in Phoenicia proper is becoming better known through the excavations at Serafend, Khaldeh, Akhziv and the unpublished material from the Iron II tombs at Byblos, we lack knowledge of the contemporary material from the coastal regions immediately to north and south. At Al Mina, however, the Phoenician wares from level VIII are strikingly different from the contemporary fabrics at Chatal Hüyük and Tell Tainat, the two best known sites in vicinity which have yielded abundant Iron II material (now in the Oriental Inst. Univ. of Chicago). One may also contrast the surface material from Sheikh Zenad in North Lebanon which is Phoenician, with the Iron Age II material from Tell Kazeel (Damascus Museum) in south-western Syria, which is not. For this reason it appears to me that the Al Mina pottery belonged to metropolitan Phoenicians, settled there as a trading group (the red-slipped wares of other western Syrian sites are nothing like the metropolitan Phoenician ware albeit of the same general family). And if in the ports, why not on the caravan routes and bazaars? And is this not the explanation of the Phoenician and exotic look of some aspects of the material culture, not only of the above named sites but also of the Jebel Kusur tombs at

28. The placing of incense stands in Phoenician tombs is well demonstrated by the occurrence of the later type, found at Samaria in Period VI, *Samaria*, p. 175, fig. 25, in cremation graves 7 and 13 at Atlit, Johns, *loc. cit.*, pp. 144, 147, figs. 12, 19. Miss Kenyon shows this type to be braziers. The same petal decoration occurs on certain examples of the earlier 'chalice' type hereunder discussion, R. S. Lamon, G. M. Shipton, *Megiddo I* (1939), pls. 33, 17, 63, 15.

29. H. Tadmor, 'Philistia under Assyrian Rule', *BA XXXIX* (Sept. 1966), p. 91.

Amman,³⁰ admittedly Ammonite, but with close Cypro-Phoenician pottery links.

The interest of Reqeish as a parallel to the graveyards of the West Mediterranean was noted by Harden (n. 9). It gives, of course, no precise parallels to West Phoenician pottery, and in this respect ranks behind Akhziv, Khaldeh and the other homeland Phoenician sites now known. Reqeish, however, forms a unique formal parallel to Carthage in that here only in the East can we document the contemporaneous use of craters, jars and pitchers in cremation burials: pitchers do not as yet appear to have been used for this purpose in Phoenicia proper. If the parallels quoted in this paper are correct, it is probable that the poorly documented cremation graves at Fara were closely analogous.

30. Unpublished material in Amman Museum, cf. R. W. Dajani's remarks, *AJDA*, XI, 1966, p. 43, on related red-slip jugs from the El Jofeh tomb at Amman. Some of the Jebel Kusar jugs are far closer to their Cypriot counterparts than the red-slip jugs from Samaria, but doubtless we are dealing with local adaptations at both sides.